

# Height Gage

A standard measuring tool of industry

## QM-Height SERIES 518 — High-Performance Height Gage

**MeasurLink® ENABLED**  
Data Management Software by Mitutoyo



- Best-in-class accuracy  $\pm(2.4 + 2.1L/600)$   $\mu\text{m}$
- Built-in air-suspension feature mechanism enables smooth movement over a surface plate. (Lower-cost version **AX** type without air suspension also available.)
- Easy-to-view, simple control panel enables most measurements to be made with a single keystroke.
- Eco-friendly product, operable for approximately 1,200 hours with four AA alkaline batteries. (Four commercially available nickel hydride batteries can also be used.)
- By installing the **U-WAVE-T** measurement data wireless communication system or USB communication driver in your PC, the optional functions that enhance operability, including output of measurement data to your PC, become available. The USB communication driver can be downloaded from the Mitutoyo website. (Communication software is separately required.) <https://www.mitutoyo.co.jp/eng/contact/products/usb/index.html>

## SPECIFICATIONS

Order No.	Metric	518-240	518-242	518-244	518-246
	Inch / Metric	518-241	518-243	518-245	518-247
Measuring range (stroke)		0 to 465 mm (350 mm / 14 in)	0 to 715 mm (600 mm / 24 in)	0 to 465 mm (350 mm / 14 in)	0 to 715 mm (600 mm / 24 in)
Resolution	Metric	0.001 mm / 0.005 mm			
	Inch / Metric	0.001 / 0.005 mm 0.00005 / 0.0001 / 0.0002 in			
Accuracy at 20 °C	Indication accuracy*1	$\pm(2.4 + 2.1L/600)$ $\mu\text{m}$			
	Repeatability*1	$2\sigma \leq 1.8$ $\mu\text{m}$			
Perpendicularity*2 (20 °C)		7 $\mu\text{m}$	12 $\mu\text{m}$	7 $\mu\text{m}$	12 $\mu\text{m}$
Guiding method		Roller bearing			
Drive method		Manual (wheel)			
Measurement principle		Electromagnetic induction absolute encoder			
Measuring force		1.5 $\pm$ 0.5 N			
Data output ports		Digimatic / USB*3			
Air-suspension feature		Not included		Included (for positioning only)*4	
Power supply		Alkaline AA / LR6 batteries $\times$ 4 (standard accessories) / AC adapter (optional accessory)*5 / Supports NiMH (HR6) rechargeable batteries $\times$ 4			
Battery life guidelines*6		Approx. 1,200 hours (without using the air-suspension feature)			
		Approx. 90 hours (when using the air-suspension feature)			
Mass		25 kg	29 kg	26 kg	30 kg
Dimensions (WxDxH)		Stroke 350 mm type: 280 $\times$ 273 $\times$ 784 mm			
		Stroke 600 mm type: 280 $\times$ 273 $\times$ 1016 mm			
Operating temperature range (recommended)		0 to 40 °C (10 to 30 °C)			
Operating humidity range		20 to 80% RH (non-condensing)			
Storage temperature range		-10 to 50 °C			
Storage humidity range		5 to 90% RH (non-condensing)			

\*1 The indication accuracy and repeatability represent the values obtained from the height measurement of a flat surface using the standard holder with  $\phi 5$  ball contact point. In the case of diameter, minimum (maximum) value, circle pitch or difference measurement, measuring errors may be larger than the accuracy ratings listed in the table due to variations in measuring force during a scanning measurement, which differs from height measurement.

\*2 Indicates the value obtained from the measurement of a straight surface placed perpendicular to the the base reference surface using the Lever Head (519-521) and Mu-checker (519-551).

\*3 Requires special communication driver. Consult your local Mitutoyo Sales Office for details.

These can be downloaded from the Mitutoyo web site. <https://www.mitutoyo.co.jp/eng/contact/products/usb/index.html>

\*4 When using a model with the air-suspension feature, it is advisable to use a JIS 1 class, or higher, surface plate. Using on surfaces with scratches or unevenness may prevent the system operating to the specified performance.

\*5 The AC adapter cannot be used to recharge rechargeable batteries.

\*6 Battery life depends on the operating conditions. In particular, it is more economical to use the optional AC adapter to power the instrument if the application requires prolonged use of the air-suspension feature.

**MeasurLink® ENABLED**  
Data Management Software by Mitutoyo

Products equipped with the measurement data output function can be connected to the measurement data network system MeasurLink® (refer to page A-25 for details).

**ABSOLUTE™**



An inspection certificate is supplied as standard. Refer to page U-9 for details.

## Standard Accessories

- **05HZA148**  $\phi 5$  mm stepped probe
- **12AAA715** Probe diameter calibration block
- Alkaline batteries $\times$ 4 (AA/LR6)

## Measurement example

- Height measurement

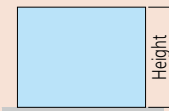

- ID measurement

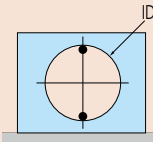

- Runout measurement

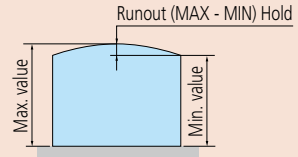

## DIMENSIONS

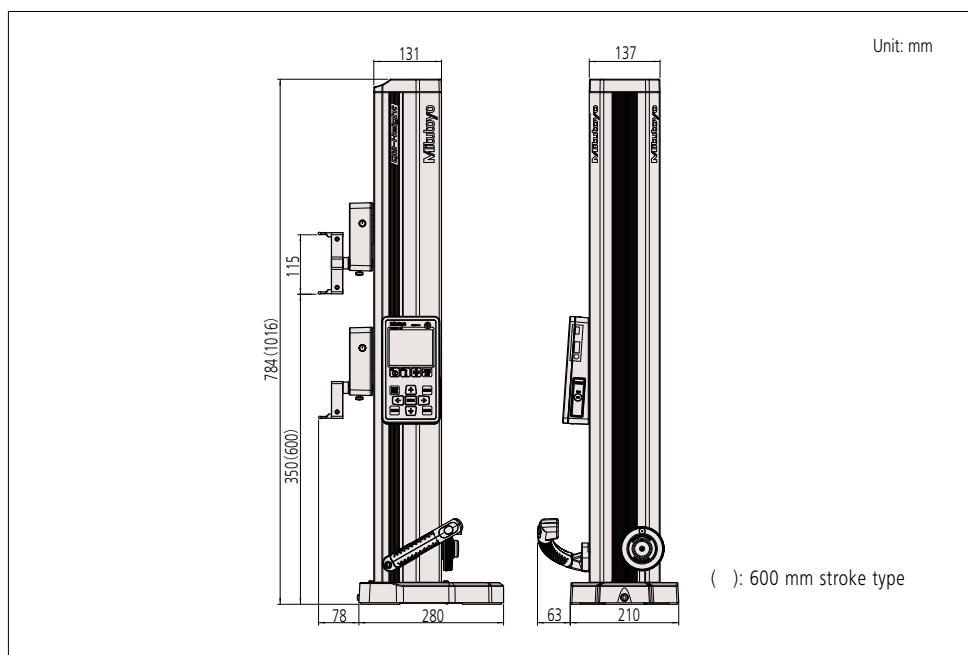

- Height difference measurement (1)  
Height A and height B from the surface plate will be displayed.

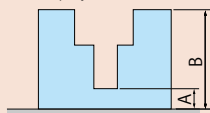

- Height difference measurement (2)  
After measuring heights A and B, the height difference C between them can be shown in the bottom row of the display.

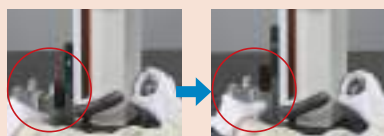
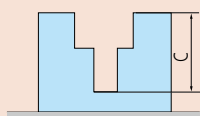

## Optional Accessories



## Optional accessories that enable centralized data management

Order No.	Item name
Small printer equipped with Data Logger	
264-505	DP-1VA LOGGER
936937	Digimatic connecting cable (1 m)
965014	Digimatic connecting cable (2 m)
06AFZ050	USB cable (A-microB)
Measurement Data Input Unit	
06AFM380D	USB Input Tool Direct USB-ITN-D
Measurement data wireless communication system	
02AZD730G	U-WAVE-T (Transmission unit) (IP67 type)
02AZD880G	U-WAVE-T (Transmission unit) (Buzzer type)
02AZD790D	U-WAVE-T dedicated cable (Standard use)
02AZE140D	U-WAVE-T dedicated cable (For foot switch)
02AZD810D	U-WAVE-R receiver
02AZE990	U-WAVE mounting plate
Measurement data collection software for Excel USB-IT PAK V2.1	
Measurement data network system MeasurLink®	

## Contact points for a wide range of measurements

Item	Order No.	Description
Depth probe		
(1)	12AAC072	Depth probe
Special holder		
(2)	12AAA792	Holder for dial indicator
(3)	12AAA793	Holder (Long)
Interchangeable contact points for ø5 mm stepped probe		
(4)	957265	ø20 mm disk
(5)	957264	ø14 mm disk
(6)	957261	ø2 mm ball (coaxial type)
(7)	957262	ø3 mm ball (coaxial type)
(8)	957263	ø4 mm ball (coaxial type)
(9)	12AAA789	ø6 mm ball (eccentric type)
(10)	12AAA788	ø4 mm ball (eccentric type)
AC Adapter		
	06AFZ950JA	AD620JA for Japan/U.S.
	06AFZ950D	AD620D for the EU
	06AFZ950E	AD620E for the UK
	06AFZ950K	AD620K for Korea
	06AEG180DC	AD620DC for China
Others		
	05HZA143	9×9 mm adapter (clamp underneath is required)
	05GZA033	Clamp (for 9×9 mm adapter)
	05HZA144	6.35×12.7 mm adapter (clamp underneath is required)
	901385	Clamp (for 6.35×12.7 mm adapter)
	05HZA173	Scriber*

\* Used for measurements, cannot be used for scribing.  
Note: A gauge block may be required for zero-setting depending on the probe or contact point to be used.